



Very early warning aspirating  
smoke detection.

---

**SecuriSmoke ASD**

## A complete model range for every application



### Large open spaces

Large open spaces such as theatres, atriums and airport terminals pose a wide range of problems in terms of fire protection. Point-type smoke detectors are often ineffective due to smoke dilution and stratification. This is where SecuriSmoke ASD aspirating smoke detectors perform reliably: these early warning devices benefit from multiple alarm levels, enabling staggered responses according to the situation for the preservation of life and property.



### Logistics and warehousing

Modern, automated and large-scale storage facilities are key infrastructures in the supply chain of almost every company. And they are sensitive: even a small fire can seriously jeopardise business continuity. Aspirating smoke detection technology ensures optimum protection. Aspirating smoke detectors from Securiton react quickly and precisely in the event of a fire; their early warning capability allows it to be brought under control before it takes hold.



### Cleanrooms and controlled environments

Controlled environments require highly reliable fire protection. At the same time, they pose particular challenges when it comes to the design and maintenance of the fire alarm system – for example, in environment-controlled production situations, in sterile zones in hospitals or in large semiconductor manufacturing facilities. SecuriSmoke ASD aspirating smoke detectors can be located in easily accessible locations: this simplifies their maintenance, and their problem-free operation minimises the risks to people and materials, thus ensuring business continuity.



### ICT infrastructure

Without a doubt, many companies would come to a standstill without a functioning ICT infrastructure. Server rooms in SMEs, mobile telephony base stations and large data centres play a key role. Protecting them from fires is a complex task, as high and turbulent air currents make it difficult to detect diluted, early-stage smoke. With their multiple alarm levels, SecuriSmoke ASD aspirating smoke detectors support appropriate interventions and enable the automatic actuation of extinguishing systems.



### Rail and rapid transit hubs

Rail hubs, including suburban rail and metro systems, are important elements of public transport. As they largely operate underground, the evacuation of trains and stations takes longer in the event of a fire. Every second counts for emergency services evacuating passengers at risk – so early notification of a potential fire is crucial. This is where SecuriSmoke ASD aspirating smoke detectors come into their own, with their multiple alarm levels and fast responses.



### Difficult environments

Large numbers of warehouses are being built to meet the increasing demands of population growth, changing consumer behaviour and innovative goods. Rapidly growing e-commerce through digitisation requires dedicated warehouses, such as cold stores, to meet the growing demand for fresh, frozen and perishable goods. SecuriSmoke ASD aspirating smoke detectors can be used in the immediate vicinity of stored goods in spite of cold or draughts. Early fire detection ensures uninterrupted business operations.

# The right device for every requirement



ASD 535-1, 1 channel



ASD 535-2, 2 channels



ASD 535-3, 1 channel  
Smoke level indicator



ASD 535-4, 2 channels  
Smoke level indicator

## ASD 535 For very large monitoring areas

- Immune to environmental contaminants such as dust, dirt, moisture and steam
- Applications: high-bay and deep-freeze warehouses, large data centres, historic buildings, large/high halls, etc.
- Approvals/certificates: VdS, DIBt, UL, FM, ActivFire, CCCF, EAC, SIL
- Total length of all sampling pipes: 2 x 400 m
- Sound pressure level: 34 dB (A), i.e. extremely low-noise
- Protection class: IP 54
- Permissible temperature range: -30 °C to +60 °C



ASD 535 HD, 1 channel  
Smoke level indicator



ASD 535 HD, 2 channels  
Smoke level indicator

## ASD 535 HD For extreme environments

- Ideal for use in corrosive environments
- Applications: metal industry, woodworking industry, agriculture, etc.
- Approvals/certificates: VdS, DIBt, UL, FM, ActivFire, CCCF, EAC, SIL
- Total length of all sampling pipes: 2 x 400 m
- Sound pressure level: 34 dB (A), i.e. extremely low-noise
- Optional surge protection
- Coated printed circuit boards
- Protection class: IP 66
- Permissible temperature range: -30 °C to +60 °C



## ASD 533 Perfect for large monitoring areas

- Reduced version with restricted system limits
- Applications: lift shafts, museums, cultural artefacts, halls, cinemas, etc.
- Approvals/certificates: VdS, UL, FM, ActivFire, EAC
- Total length of all sampling pipes: 200 m
- Sound pressure level: 34 dB (A), i.e. extremely low-noise
- Protection class: IP 54
- Permissible temperature range: -20 °C to +60 °C



## ASD 532 For medium-sized monitoring areas

- Compact design
- Applications: prison cells, clean rooms, laboratories, IT racks, telecommunications equipment, etc.
- Approvals/certificates: VdS, UL, FM, ActivFire, CCCF, EAC, SIL
- Total length of all sampling pipes: 120 m
- Sound pressure level: 25 dB (A), i.e. extremely low-noise
- Protection class: IP 54
- Permissible temperature range: -20 °C to +60 °C



## ASD 531 For small monitoring areas

- Simple three-step configuration at the device itself (no software/PC)
- Applications: individual IT racks, clean rooms, false ceilings, etc.
- Approvals/certificates: VdS, UL, FM, ActivFire, CCCF, EAC
- Total length of all sampling pipes: 75 m
- Sound pressure level: 25 dB (A), i.e. extremely low-noise
- Protection class: IP 54
- Permissible temperature range: -10 °C to +55 °C



## NetSoft: for a perfect overview and simple operation

The NetSoft software tool visualises live data from aspirating smoke detectors on a PC for a comprehensive overview and configuration options for the entire system.

### Graphical user interface

The building plan provides an overview of all the ASDs in the network, including their current states. Netsoft's graphical interface offers complete flexibility when creating and importing simple networked floor plans as well as complex building graphics. The states of the networked ASDs can be viewed at a glance: the relevant ones are highlighted in colour in the event of an alarm, malfunction or other status.

### Operation and configuration

NetSoft enables individual selection of the graphical detector icons and access to the data of the networked detectors. You can also configure the devices directly from the graphical overview. To display the live data of the detectors or carry out further configurations and parameterisations of the individual ASDs, you can start the ASD Config tool in NetSoft.

## FidesNet: the intelligent networking solution

Deploying FidesNet turns SecuriSmoke ASD aspirating smoke detectors into a full-fledged, intelligent system with central visualisation and control functions. Proven components ensure secure networking.

### Function

FidesNet enables multiple SecuriSmoke ASDs to be interconnected using a serial RS-485 interface. The SIM-35 module serves as a serial interface module. The FidesPort NCU 900 regulates communication in the network and integrates it into a higher-level system – e.g. a building management system (BMS) or the NetSoft visualisation system (see right). The FidesPort NCU 900 supports standard interfaces such as Modbus TCP for data forwarding. A RS-485 network enables up to 100 ASDs and 50 RCUs to be connected to an NCU 900.

### Applications

FidesNet is used wherever remote visualisation and operation of aspirating smoke detectors is needed – for example in airport security zones, laboratories, IT environments, etc. Another application is central visualisation and operation in a security command centre in order to monitor a complete installation from one location. FidesNet is also indispensable for connecting to other systems via standardised interfaces. If, for example, the security management system of a data centre receives relevant ASD data, the operator can call up the current status of the safety system.

### FidesControl RCU 700 – important information at the right time

The 7-inch touch panel on the FidesControl unit impresses with its clearly designed interface and optimum user guidance. Its display shows all the data of the networked ASDs. The detectors can be isolated by channel and are easy to reset in the event of an error or alarm.

### Networking with a fire alarm control panel – easy to configure and maintain centrally

The detection devices communicate directly with the SecuriFire alarm control panel via the addressable loop – also during commissioning and maintenance. This significantly reduces the amount of maintenance required: there is no need for routes to the devices, and thanks to Config over Line, all activities are efficiently carried out from the fire alarm control panel.

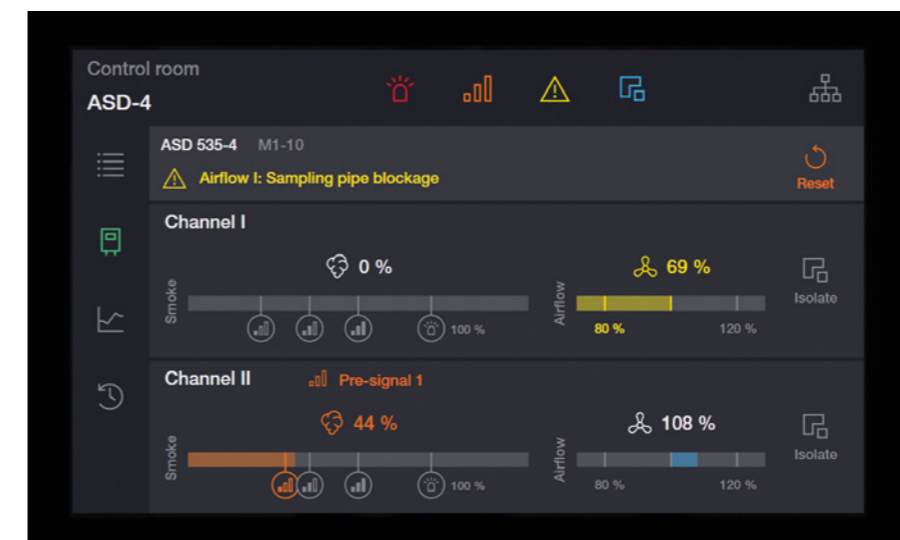

RCU 700 – the important information at the right time

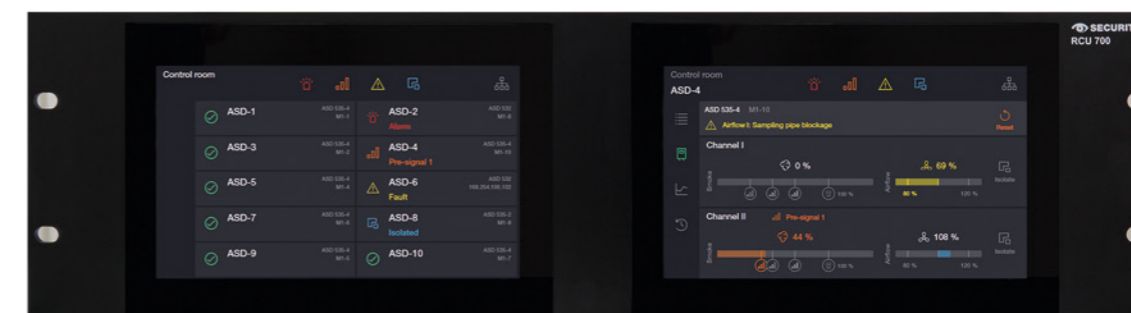

# ASD PipeFlow and BIM: planning made easy

Planning complex systems – e.g. with asymmetrical sampling pipes? This is easy with the ASD PipeFlow sampling pipe calculation software. And planning is more efficient with our BIM models.

## ASD PipeFlow for straightforward planning

ASD PipeFlow guides you to your goal using simple, logical steps: at the end of the planning phase, the SecuriSmoke ASD aspirating smoke detectors deliver maximum benefits – and meet the standards-compliant response grades according to EN 54-20 (Classes A, B and C) and NFPA 72. With its practical optimisation function, the calculation software always looks for the ideal balancing of the sampling pipes so that each sampling hole has the same sensitivity. Accessories for the sampling pipe are also all integrated in the VdS-approved software.

## Efficient building planning with BIM

Building information modelling (BIM) is now well-established in modern planning. Securiton offers BIM models in Revit for its products – including SecuriSmoke ASDs. Planning becomes more efficient: You can identify planning errors early on and reduce planning costs and working times: BIM automatically calculates the system dimensions and costs.

ASD PipeFlow – mastering complexity

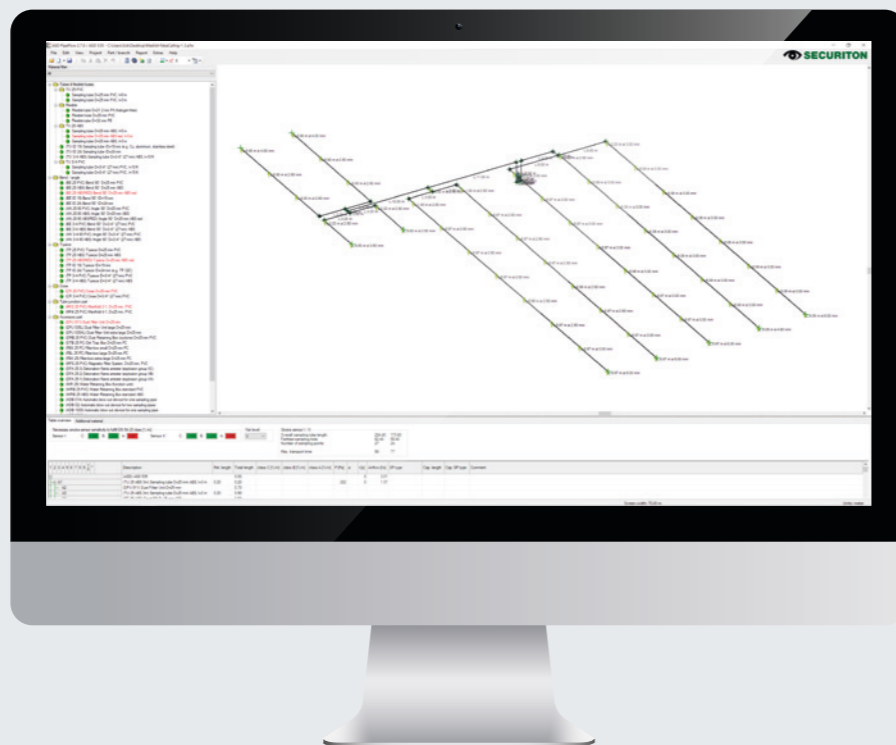

# ASD Config: configuration from a single source

Use the practical ASD Config software tool for commissioning and application-specific tailoring at the device.

## Optimal configuration cuts costs

ASD Config enables you to configure your aspirating smoke detectors efficiently, conveniently and securely. The software's extensive analysis functions and setting options provide you with important information for safe and economical operation: this makes maintenance easy, even in hard-to-reach installation locations, and eliminates operational interruptions and faults. Thanks to RS-485 networking, you can also visualise and operate all networked ASDs (ASD 535 and 532) at the same time.

## Get away from complexity – with our ASD tools

- ASD Config software for complete device setting and analysis
- ASD PipeFlow software for efficient planning, VdS-approved
- BIM models for smart building planning
- Config over Line for central configuration, commissioning and maintenance without physical access to the device

ASD Config – simple configuration and analysis

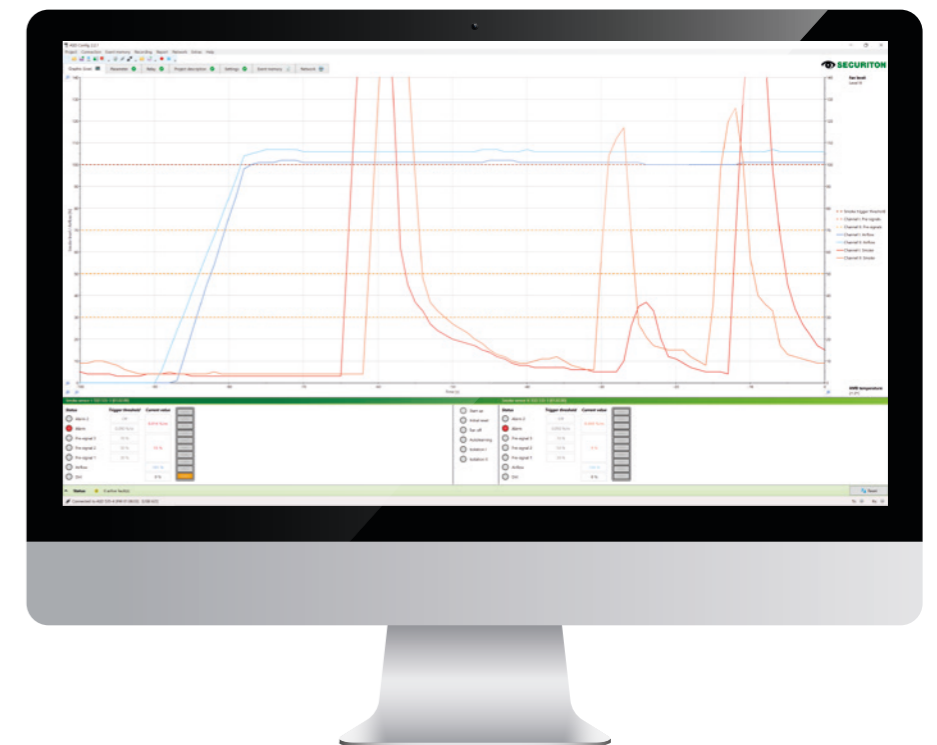

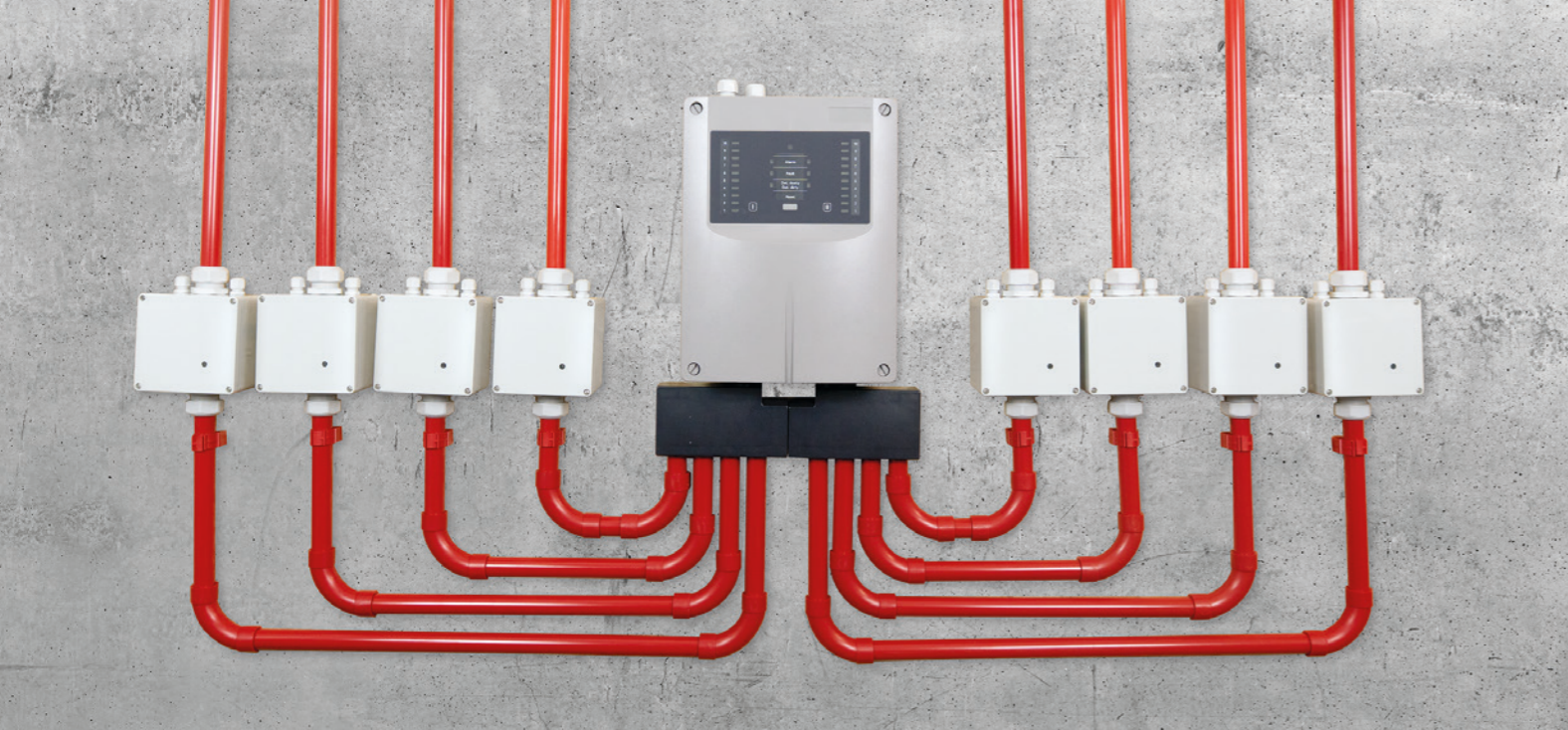

## Demanding applications: every situation under control

Highly robust, whisper-quiet and precise responses to minimal amounts of smoke: SecuriSmoke ASD aspirating smoke detectors meet the highest standards.

## Multichannel applications

Many applications call for the aspirating smoke detector pipework to be divided into several channels. Individual pipe detection is also available as an option. In addition to two smoke sensors, SecuriSmoke ASDs also have a pipe splitter and REK sensors, which can be integrated directly into the sampling pipe.

### Pipe manifold

If more than two pipes are required, pipe manifolds are a simple solution. These can be connected directly to the ASDs, so that they can be expanded to accommodate up to eight sampling channels.

### Channel and cabinet identification

An ASD aspirates the air from many locations/points at the same time. Precise identification of where the smoke comes from is possible with our REK solution, such as in control cabinets, false ceilings and floors.

### Further benefits

- Easy-to-install pipe manifolds
- Can be expanded to include up to eight sampling channels
- Pipe manifolds can be connected directly to the ASD
- REKs are flexibly deployable/expandable
- Signals from four REKs can be processed directly with the ASD
- Channel identification for single pipe detection
- Precise information about where the smoke has been aspirated

### Two-detector dependency

The SecuriSmoke ASD is available as a two-channel version with two independent smoke detectors in the same detector housing.

- Use for extinguishing actuation
- Reduced installation work, as one housing contains two detectors

### High IP protection

SecuriSmoke ASDs feature protection class IP 54 as standard: protection against dust, contact protection and splashed water. This makes them suitable for use in dusty industrial environments. ASD 535 HD models meet the stringent requirements of protection class IP 66. They are dust-tight and resistant to strong jets of water – ideal for use in extreme environments such as those common in agriculture.

### Quiet operation

The sound of air being aspirated by SecuriSmoke ASDs is barely noticeable. Thanks to their minimal noise, they can be installed in places where peace and quiet is paramount: museums, hospitals, wellness facilities, churches, etc.

- ASD 535/533 = 34 dB (A)
- ASD 532/531 = 25 dB (A)

### Very high sensitivity

The smoke sensor in SecuriSmoke ASDs is designed for use in extremely sensitive environments. Its sensitivity is 0.002 % Obs/m, which corresponds to an extremely low amount of smoke in the air. SecuriSmoke ASDs can be used in critical facilities (e.g. computer centres) where Class A devices are specified.

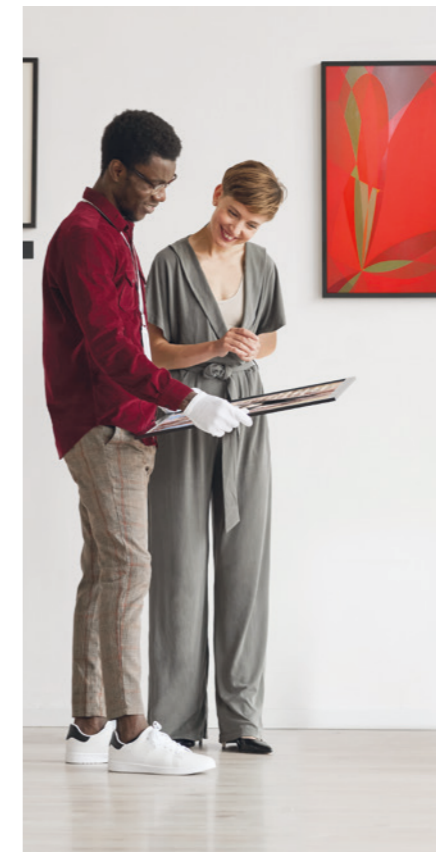

## Complete range of accessories: the right parts for every application

### Industrial applications

Accessories for harsh environments.



### Optional modules

Functional enhancement for ASDs.

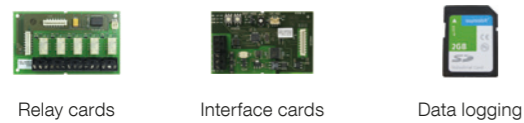

### Standard applications

Securiton offers a comprehensive range of accessories for a complete installation.



### Premises monitoring

For the demanding protection of premises.



### Applications in deep-freeze facilities

Equipment for sub-zero temperatures.

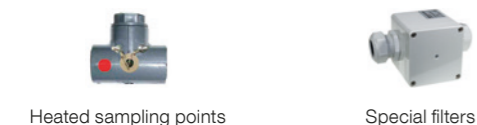

### Accessories for Ex zones

For increased requirements in potentially explosive environments.

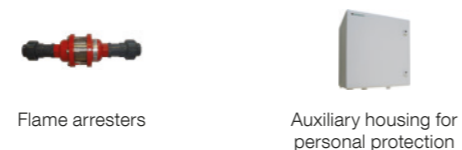

## In use around the world with globally applicable certifications

Global product tests and certifications enable SecuriSmoke ASDs to be deployed in any market in the world.

SecuriSmoke ASDs speak multiple languages: globally applicable standards such as NFPA 72, FIA Code of Practice, VDE 0833-2, TS 54-14, BS 5839-1, etc. can be met in all confidence when planning a system.

📍 Securiton has a global presence. Our headquarters are located in Switzerland, and we have subsidiaries or local staff operating in Mexico, Brazil, Spain, Russia, India, Malaysia and China.



# Overview of the aspirating smoke detectors: SecuriSmoke ASD

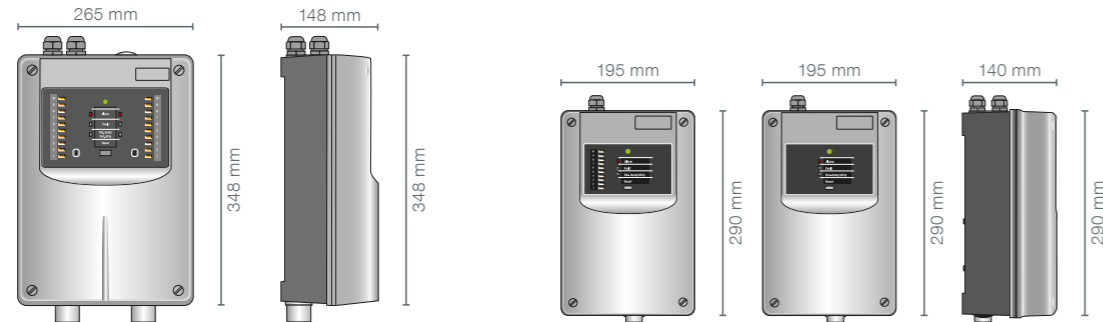

	ASD 535	ASD 533	ASD 532	ASD 531
<b>Product details</b>				
Channels	1/2	1	1	1
Smoke sensor	Highly sensitive smoke sensor with high-power LED, LVSC smoke chamber and patented lint filter			
Monitoring area	5760 m <sup>2</sup>	1920 m <sup>2</sup>	1280 m <sup>2</sup>	720 m <sup>2</sup>
Smoke level indicator	Option (Versions -3 and -4)	No	Series	No
Programming (PC tool)	ASD Config	ASD Config	ASD Config	Not available
Configuration	EasyConfig	EasyConfig	EasyConfig	BasiConfig
Sampling pipe calculation	ASD PipeFlow	ASD PipeFlow	ASD PipeFlow	ASD PipeFlow
Applications	High-bay warehouses, deep-freeze warehouses, large data centres, historic buildings, large/high halls, etc.	Lift shafts, museums, cultural artefacts, halls, cinemas, etc.	Prison cells, clean rooms, laboratories, IT racks, telecommunications equipment, etc.	Individual IT racks, clean rooms, false ceilings, etc.
Coated printed circuit boards and surge protection	HD version	—	—	—
Approvals/certificates	VdS, DIBt, UL, FM, ActivFire, CCCF, EAC, SIL	VdS, UL, FM, ActivFire, EAC	VdS, UL, FM, ActivFire, CCCF, EAC, SIL	VdS, UL, FM, ActivFire, CCCF, EAC

		ASD 535	ASD 533	ASD 532	ASD 531
<b>Technical data</b>					
Supply voltage range	EN 54 FM/UL	10.5 to 30 VDC 12.4 to 27 VDC	10.5 to 30 VDC 12.4 to 27 VDC	14.0 to 30 VDC 16.4 to 27 VDC	14.0 to 30 VDC 16.4 to 27 VDC
Power consumption	Type at 24 VDC	260 to 290 mA	210 mA	115 mA	75 mA
Alarm sensitivity	Alarm Pre-signal	0.02 to 10%/m (0.00087–0.457 dB/m) From 0.002%/m (0.0000869 dB/m)			0.02 to 10%/m From 0.006%/m
Alarm levels		5 (3 pre-signals, alarm, alarm 2) Adjustable pre-signals 10 to 90%			4 (3 pre-signals permanently set 30/50/70%)
Number of sampling holes (with ASD PipeFlow)	EN 54-20, Class A	2 × 18	16	8	6
	EN 54-20, Class B	2 × 56	50	12	8
	EN 54-20, Class C	2 × 120	50	16	12
System limits compliant with EN 54-20, Class C	Max. overall length of all sampling pipes	2 × 300 m	200 m	120 m	75 m
System limits without standards conformity	Max. overall length of all sampling pipes	2 × 400 m	200 m	120 m	75 m
Fan/aspirating system	Suction pressure	> 400 Pa	> 400 Pa	> 100 Pa	> 30 Pa
	Sound pressure level	> 34 dB (A)	> 34 dB (A)	> 25 dB (A)	> 25 dB (A)
Housing	Protection type	IP 54 (IP 66: HD version)	IP 54	IP 54	IP 54
Operating temperature/humidity	Evaluation unit	–30 to +60 °C/ 95% RH (UL max. +40 °C)	–20 °C to +60 °C/ 95% RH (UL max. +40 °C)	–20 °C to +60 °C/ 95% RH (UL max. +40 °C)	–10 to +55 °C/ 95% RH (UL max. +40 °C)
Relay	Number of 1-channel versions	3 (1 alarm, 1 fault, 1 free)	3 (1 alarm, 1 fault, 1 free)	2 (1 alarm, 1 fault)	
	2-channel version	3 (each 1 alarm I and II alarms, 1 fault)		(use RIM 36 for pre-signals)	
	Contact load	50 VDC/1 A (UL 30 VDC)			
Interfaces	Open collector outputs	As relays	As relays	As relays	As relays
	PC tool	USB	USB	Ethernet	—
	Network	RS 485	—	RS 485, Ethernet	—
	Inputs	Reset, day/night	Reset, day/night	Reset, day/night	Reset
SecuriFire integration	Yes, with XLM-35 module (alarm, pre-signal, faults, day/night sensitivity switching, reset, etc.)				
Event memory/analogue values	On board	430 events	1000 events	1000 events	1000 events





**Securiton AG**

Alarm and Security Systems  
Alpenstrasse 20, CH-3052 Zollikofen  
[www.securiton.com](http://www.securiton.com), [info@securiton.com](mailto:info@securiton.com)

A company of the Swiss Securitas Group

---